

Installation instructions

Troldtekt® acoustic panels K0, K5, K5-V, K11
Installed with Troldtekt self-tapping screws on C60 profiles,
suspended with adjustable suspension brackets (27-120 mm)

TROLDTEKT® ACOUSTIC PANELS

K0: Square edge

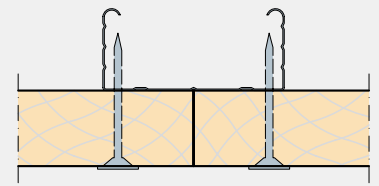
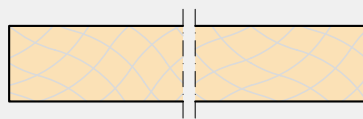

K5: 5 mm bevel

K5-V: 5 mm bevel and v-groove

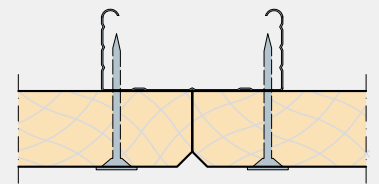
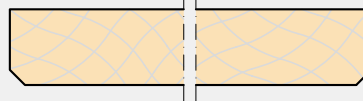

K11: 11 mm bevel

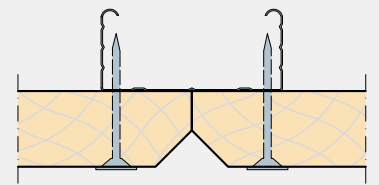

INSTALLED ON C60 PROFILES, SUSPENDED WITH ADJUSTABLE SUSPENSION BRACKETS (27-120 MM)

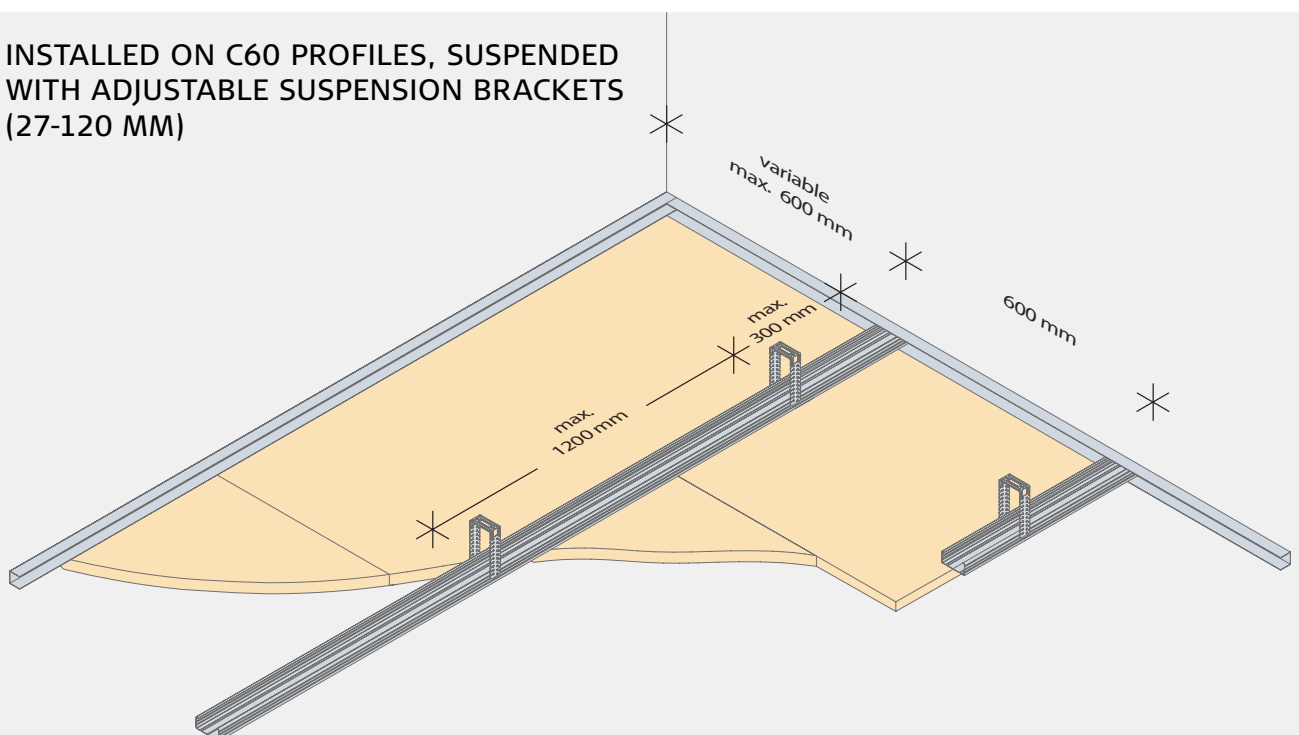

STORAGE AND ACCLIMATISATION

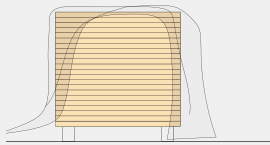

Outdoor storage

If it is necessary to store Troldekt panels outdoors, you should protect the panels using a tarpaulin or similar. Please note that outdoor storage should be as brief as possible and never directly on the ground.

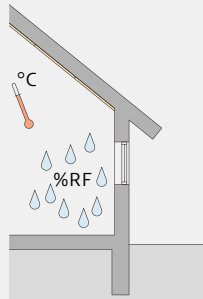

Indoor storage

If you store Troldekt panels indoors, you must remove any packaging, as condensation could otherwise form within the packaging. Care should be taken to protect stored Troldekt panels from moisture, direct heat and dust.

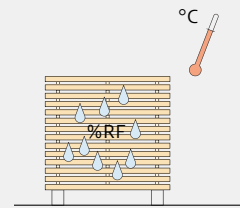

Acclimatisation

It is important that the Troldekt panels are allowed to acclimatise prior to installation. Acclimatisation means that the panels must adapt to the temperature and humidity in the room where they are to be installed.

COMPONENTS

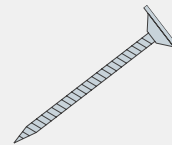

Product name	C60 main profile 60×27 mm	C-connector	Troldekt self-tapping screw
Length (mm)	4000	80	3.9×45
Quantity per pack	12 pcs.	100 pcs.	100 pcs.
Approx. qty. per m ²	1.7 linear m	0.4 pcs.	Panel length: 600: 4 pcs. per panel 1200: 6 pcs. per panel 2400: 10 pcs. per panel

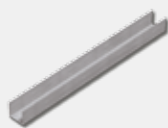

Product name	Perimeter angle profile 28×27 mm	Adjustable suspension bracket
Length (mm)	3000	27-120
Quantity per pack	16 pcs.	100 pcs.
Approx. qty. per m ²	According to measurement	1.4

STRUCTURAL SOFFIT

1: Mark the horizontal ceiling at the required height on all adjoining walls. Mark the lower side of the perimeter profile and fix it to the wall using 6-mm dowels in pre-drilled holes. Determine and mark the anchor points for the main profiles. Always install the first adjustable suspension bracket max. 300 mm from the wall. Distribute the remaining adjustable suspension brackets with a max. spacing of 1200 mm.

2: Hold a main profile with the opening facing upwards and screw the adjustable suspension bracket to the side of the profile at the desired height. Bend back any excess section of the adjustable suspension bracket. Assemble the perimeter profiles to the appropriate length using C-connectors, and lap the main profiles on the perimeter

profile. If possible, divide the ceiling space to allow for adjustments of min. 300 mm on both sides.

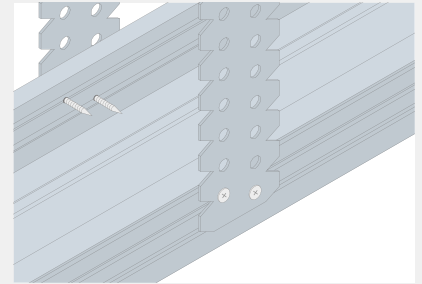
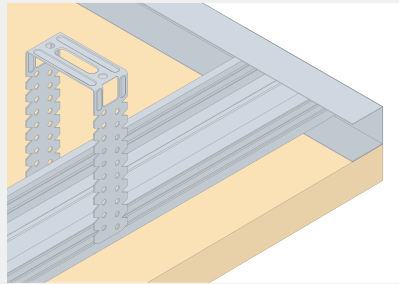
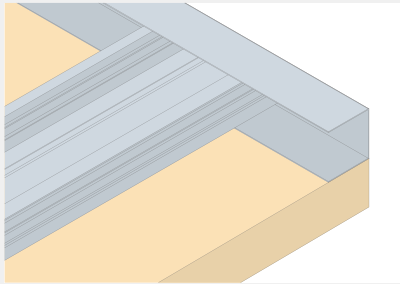

INSTALLATION

1: Start by installing a complete row of Troldtekt panels along the centre line of the room and work with rows of panels from the centre. It is important that the panels are mounted closely together, and the optimum aesthetic effect is obtained by installing the panels in broken bond.

2: Fix the panels using Troldtekt self-tapping screws spaced 25/20 mm from the edges – as indicated in the figure below. Be careful not to overdrive the washered screws and so cause an indentation in the panel.

Please note: When installing 600×600 mm panels, it is important to ensure that the wood wool fibres in the panels run mainly parallel in one direction, as the ceiling might otherwise lose its uniform look. Install the panels so that the printed Troldtekt text on the back of the panels all run in the same direction.

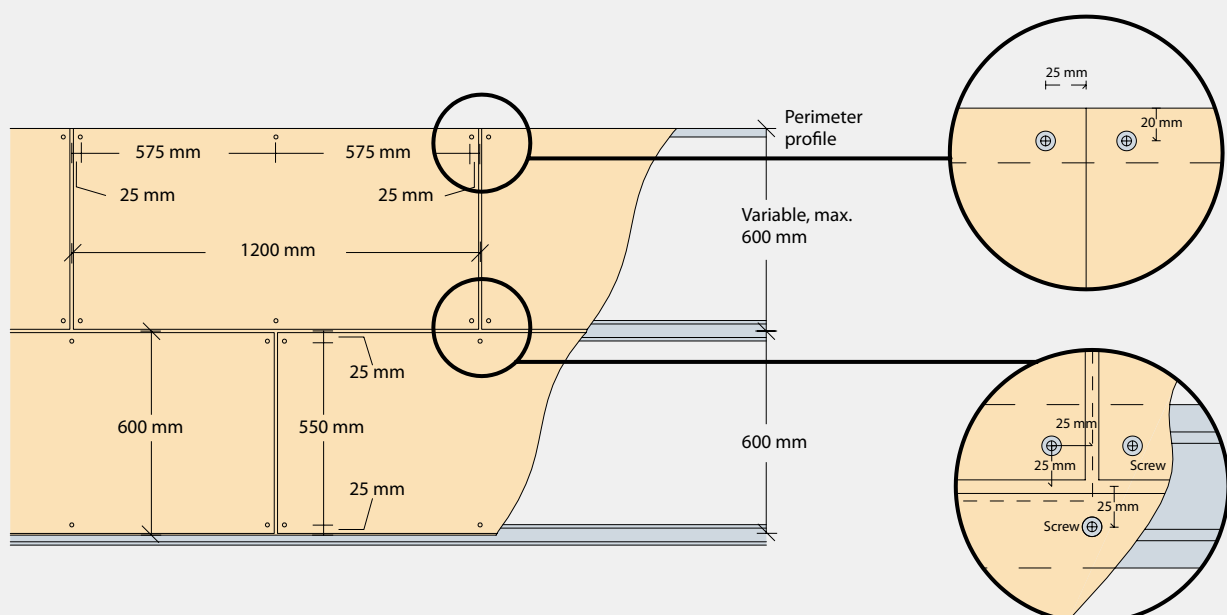

INSPECTION ON RECEIPT

On receipt, check that the number of panels is correct and that the panels do not have visible flaws and defects. Please inform the supplier immediately in case of defective

panels, as we cannot accept claims regarding visible flaws and defects after the panels have been installed.

AFTER INSTALLATION

Remove any processing dust with a vacuum-cleaner with a brush nozzle.

If the installation process has left lines or other dirt on natural wood panels, you can

remove these by using a slightly damp cloth. Touch-up paint is available as required.

SUBSEQUENT CARE AND MAINTENANCE

Troldtekt panels usually require no subsequent care. However, we recommend regular cleaning along with other surfaces – and otherwise as required.

Use a vacuum cleaner with a brush nozzle. If vacuum-cleaning is not sufficient, you can

wipe the panels using a slightly damp cloth. If you subsequently want to paint the Troldtekt ceiling, you can use a long-haired paint roller or a hand sprayer. Water-based paint will not reduce the sound-absorbing performance of the panels.

PRODUCT STANDARDS, LABELLING AND CERTIFICATES

The table below indicates the size tolerances declared by us in accordance with the standard for cement-bonded wood wool (EN 13168) and the standard for suspended ceilings (EN 13964). It is important to note that Troldtekt is a natural material and the very nature of the material composition – wood wool and cement – may result in small variations in the thickness of the panels. Panel dimensions and weights

remain inside the tolerance indicated at 23 +/- 2° C and 50 +/- 5% relative humidity. However, inappropriate storage and lack of acclimatisation can alter the dimensions and weight of the panels. It is therefore important that you observe the installation, storage and acclimatisation instructions carefully.

Due to the composition of the materials, colour shade variations may occur.



Godkendelse
MK 6.31/0379



THICKNESS (mm)	WIDTH (mm)	LENGTH (mm)	WEIGHT (kg/m ²)	NO. OF PANELS (per pallet)	PERPENDICULARITY (mm)	PLANENESS (mm)
25	600	600 1200 2000 2400	9.7	80* 80 40 40	≤2	≤3
(+/- 1.5)	(+/- 1)	(+/- 1.5)	(+/- 10%)			
35	600	600 1200 2000 2400	12.0	56* 56 28 28	≤2	≤3
(+/- 1.5)	(+/- 1)	(+/- 1.5)	(+/- 10%)			

*600×1200 mm pallet

FURTHER INFORMATION

On www.troldtekt.com you can read more about Troldtekt products. You can also download the most recent version of these

installation instructions and see the complete range of Troldtekt installation instructions.



Troldtekt A/S
Sletvej 2 A
DK-8310 Tranbjerg J
Tel. +45 8747 8100
Fax +45 8747 8111
info@troldtekt.dk

www.troldtekt.com